

COMANSA LC290-18t

2214 HWY. 1187 BLDG. 1
Mansfield, TX 76063

513 Thompson Ln.
Austin, TX 75742

office: 817-225-1090 Fax: 817-225-1035

www.suncraneandhoist.com

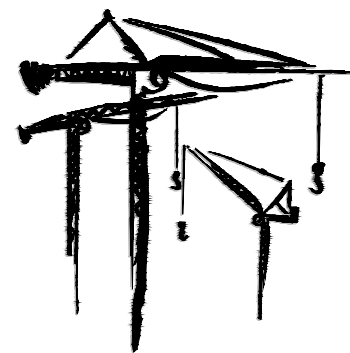

SUN
CRANE & HOIST

LINDEN  COMANSA

LC290-18t

Topless Tower Crane



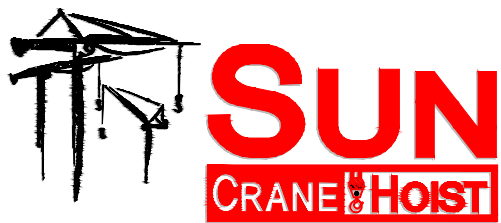

Topless Tower Crane
Modular System

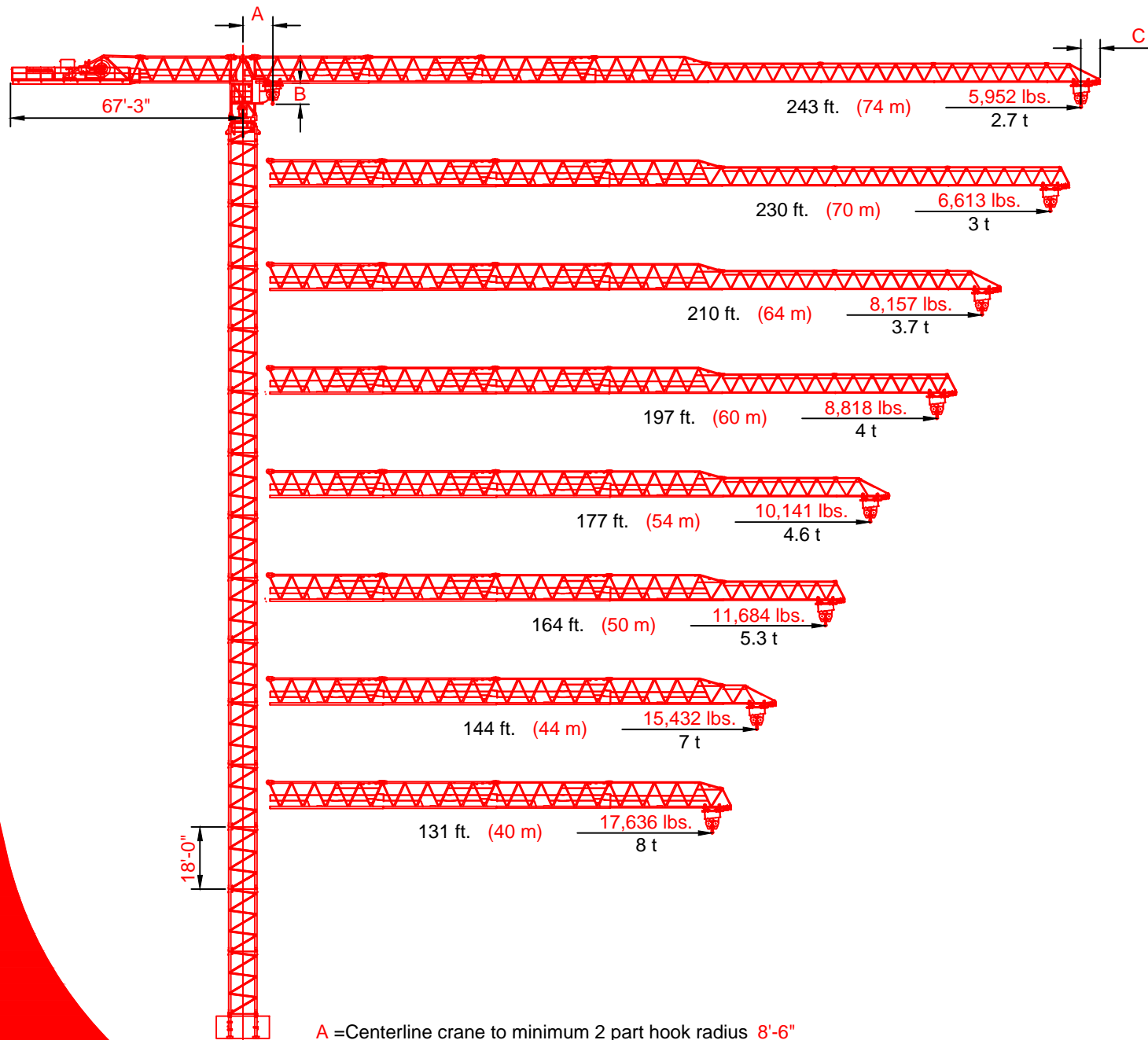

A =Centerline crane to minimum 2 part hook radius 8'-6"
 B =Bottom of jib to hook block 6'-7"
 C =Add for jib tip radius 6'-7"

Line Speeds and Power Requirements

Power Requirements

87 hp (65 kW)

2 - Part Line	Line Speed	Capacity
19,850 lbs. 9 t	196 ft/min 59.7 m/min	6,610 lbs. 3 t
	328 ft/min 100 m/min	13,225 lbs. 6 t
	459 ft/min 139.9 m/min	19,840 lbs. 9 t

4 - Part Line	Line Speed	Capacity
39,680 lbs. 18 t	98 ft/min 29.9 m/min	13,225 lbs. 6 t
	164 ft/min 50 m/min	26,450 lbs. 12 t
	229 ft/min 69.8 m/min	39,680 lbs. 18 t

Unit	Kilowatts	Speed
TROLLEY	10	7.5 0 - 308 ft/min 0 - 94 m/min
SWING	3 x 10 hp	3 x 7.5 0 - 0.7 rpm

Power Requirements

480 volts, 3 phase, 60 Hz, 300 amp service

Additional Equipment and Services Available

- Comedil Tower Cranes
- Peiner Tower Cranes
- Sun Tower Cranes
- Comansa Tower Cranes
- Timberland Derricks
- Hercules Elevators
- Specialized Rigging
- Technical Services
- Third Party Inspections
- Parts and Repair Services
- Erection and Dismantlement Services

*Due to product improvement specifications are subject to change without notice.

EQUIPMENT RENTALS - SALES- 24 HOUR SERVICE - YARD STORAGE & TRANSFERS - REGIONAL SERVICE

2214 FM 1187, SUITE 1
 MANSFIELD, TX 76063
 OFFICE: 817-225-1090 FAX: 817-225-1095

513 THOMPSON LN.
 AUSTIN, TX 78742
 OFFICE: 817-789-2007 FAX: 817-225-1095









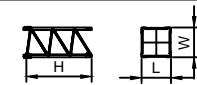

WWW.SUNCRANEANDHOIST.COM

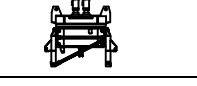

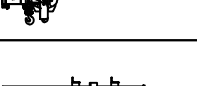

Crane Component List

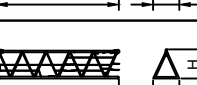
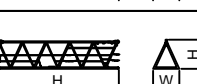
LC290 - 18t

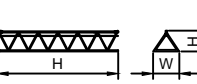
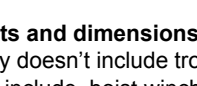
Radius and Capacities

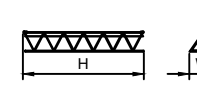
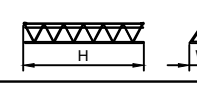
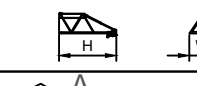
LC290 - 18t

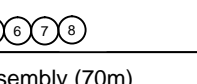
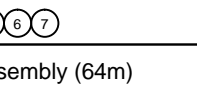
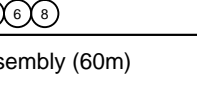
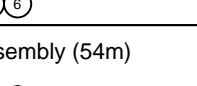
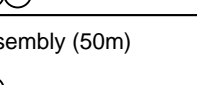
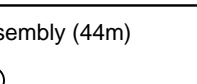
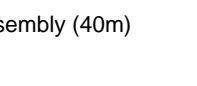
DESCRIPTION	DIMENSION L x W x H	WEIGHT
Tower Section S35 	8'7"x8'7"x18' 2.6mx2.6mx5.4m	8,160lbs. 1,307kg
Climbing Unit w/ Platform 	8'7"x8'7"x18' 2.6mx2.6mx5.4m	26,510lbs. 4,246kg
Turntable SM218/S35 	10"x10'3"x10' 3mx3.1mx3m	19,620lbs. 3,142kg
Cathead SM218 	8.20"x5.25"x22' 2.5mx1.6mx6.7m	11,025lbs. 1,766kg
Counterdeck FM215 	8.20"x5.25"x22' 2.5mx1.6mx6.7m	7,210lbs. 1,154kg
Counterdeck BM215 EFU4-65-45 	8.20"x5.25"x22' 2.5mx1.6mx6.7m	24,691lbs. 3,955kg
Hook Block 	8.20"x5.25"x22' 2.5mx1.6mx6.7m	1,245lbs. 199kg
Anchors (4x) PD3-2 	8.20"x5.25"x22' 2.5mx1.6mx6.7m	610lbs. 97kg
AM282A Jib Section ① 	33'9"x8'1"x4.6' 10.3mx2.4mx1.04m	10,690lbs. 1,712kg
AM272A Jib Section ② 	33'8"x7'9"x4.6' 10.3mx2.4mx1.04m	9,480lbs. 1,518kg
AM262A Jib Section ③ 	33'7"x7'9"x4.6' 10.3mx2.4mx1.04m	7,930lbs. 1,270kg
AM250A Jib Section ④ 	33'6"x7'8"x4.6' 10.2mx2.4mx1.04m	5,090lbs. 815kg
AM240 Jib Section ⑤ 	33'6"x5'8"x4'6" 10.2mx1.7mx1.4m	3,770lbs. 603kg

DESCRIPTION	DIMENSION L x W x H	WEIGHT
AM230 Jib Section ⑥ 	8.20"x5.25"x22' 2.5mx1.6mx6.7m	2,890lbs. 462kg
AM220 Jib Section ⑦ 	8.20"x5.25"x22' 2.5mx1.6mx6.7m	2,050lbs. 328kg
AM244 Jib Section ⑧ 	8.20"x5.25"x22' 2.5mx1.6mx6.7m	660lbs. 105kg
Counterweights A B C 	8.20"x5.25"x22' 2.5m x1.6m x6.7m	A- 8,818 B- 4,409 C- 2,204
243 ft. Jib Assembly (74m) ①②③④⑤⑥⑦⑧ 	242'x8'1"x243' 73.7m x2.49m x74m	66,330 lbs 10,625 kg
230 ft. Jib Assembly (70m) ①②③④⑤⑥⑦ 	230'x.8'1"x243' 70.1m x2.5m x74m	63,440 lbs 10,162 kg
210 ft. Jib Assembly (64m) ①②③④⑤⑥⑧ 	210'x.8'1"x243' 64.0m x2.5m x74m	62,120 lbs 9,950 kg
197 ft. Jib Assembly (60m) ①②③④⑤⑥ 	197'x8'1"x243' 60m x2.5m x74m	53,300 lbs 8,537 kg
177 ft. Jib Assembly (54m) ①②③④⑤⑧ 	177'x8'1"x243' 54m x2.5m x74m	43,160 lbs 6,913 kg
164 ft. Jib Assembly (50m) ①②③④⑤ 	164'x8'1"x243' 50m x2.5m x74m	42,290 lbs 6,774 kg
144 ft. Jib Assembly (44m) ①②③④⑧ 	144'x8'1"x243' 43.8'm x2.5'm x74'm	41,090 lbs 6,581 kg
131 ft. Jib Assembly (40m) ①②③④ 	131'x8'1"x243' 40'm x2.5'm x74'm	40,200 lbs 6,439 kg

Radius and capacity (meter and tons)		2-Part - line									
		m									
Hook Radius		98	111	131	134	160	177	196	209	229	242
74 m	19,842 lbs - 85 ft	16,887	14,682	12,224	11,893	9,700	8,664	7,660	7,098	6,371	5,952
70 m	19,842 lbs - 82 ft	17,460	15,189	12,665	12,312	10,052	8,983	7,947	7,363	6,613	
64 m	19,842 lbs - 85 ft	19,191	16,710	13,944	13,569	11,100	9,931	8,796	8,157		
60 m	19,842 lbs - 95 ft	19,202	16,721	13,966	13,580	11,122	9,953	8,818			
54 m	19,842 lbs - 95 ft	19,543	17,030	14,219	13,833	11,320	10,141				
50 m	19,842 lbs - 101 m	19,841	17,945	14,991	14,583	11,948					
44 m	19,842 lbs - 115 ft	19,841	19,841	17,140	16,677						
40 m	19,842 lbs - 115 ft	19,841	19,841	17,636							

Radius and capacity (meter and tons)		4-Part - line									
		m									
Hook Radius		96	109	128	134	160	177	194	209	227	240
74 m	39,683 lbs - 49.5 ft	16,534	14,175	11,783	11,166	8,818	7,837	6,724	6,106	5,302	4,850
70 m	39,683 lbs - 50.8 ft	17,019	14,594	12,147	11,519	9,104	8,101	6,966	6,327	5,511	
64 m	39,683 lbs - 54.8 ft	18,584	15,972	13,326	12,654	10,052	8,972	7,738	7,054		
60 m	39,683 lbs - 54.8 ft	18,452	15,862	13,249	12,577	9,997	8,928	7,761			
54 m	39,683 lbs - 55.4 ft	18,650	16,038	13,392	12,720	10,119	9,038				
50 m	39,683 lbs - 57.7 ft	19,576	16,854	14,098	13,392	10,681					
44 m	39,683 lbs - 64.3 ft	22,266	19,213	16,126	15,344						
40 m	39,683 lbs - 65.6 ft	22,806	19,687	16,534							

Radius and capacity (meter and tons)		2-Part - line									
		m									
Hook Radius		30	34	40	44	50	54	60	64	70	74
74 m	9 t - 26 m	8	7	5.54	4.97	4.30	3.93	4.01	3.21	2.90	2.69
70 m	9 t - 25 m	8	7	5.74	5.15	4.55	4.07	4.07	3.33	2.99	
64 m	9 t - 25 m	8.7	7.58	6.33	5.69	4.92	4.51	4.41	3.69		
60 m	9 t - 29 m	8.7	7.58	6.33	5.31	4.92	4.51	4.41			
54 m	9 t - 29 m	8.86	7.72	6.44	5.80	5.01	4.90				
50 m	9 t - 31 m	9	8	6.8	6.11	5.2					
44 m	9 t - 35 m	9	9	8	6.9						
40 m	9 t - 35 m	9	9	8							

Radius and capacity (meter and tons)		4-Part - line									
		m									
Hook Radius		30	34	40	44	50	54	60	64	70	74
74 m	18 t - 15.1 m	7.5	6.65	5.34	4.71	3.96	3.96	3.05	2.77	2.67	2.32
70 m	18 t - 15.5 m	7.72	6.62	5.51	4.86	4.09	4.09	3.16	2.87	2.76	
64 m	18 t - 16.7 m	8.43	7.24	6.04	5.34	4.51	4.51	3.51	3.19		
60 m	18 t - 16.7 m	8.37	7.19	6.01	5.31	4.49	4.49	3.52			
54 m	18 t - 16.9 m	8.46	7.72	6.07	5.38	4.55	4.55				
50 m	18 t - 17.6 m	8.88	7.64	6.39	5.66	4.8					
44 m	18 t - 19.6 m	10.1	8.7	7.3	6.5						
40 m	18 t - 20 m	10.34	8.93	7.5							

NOTE: Weights and dimensions are approximate. Weigh components before lifting.

1. Jib assembly doesn't include trolley, pulley support and load block
2. Counter-Jib include, hoist winch, handrails, platforms and tie bars
3. Turntable complete does not include platform
4. Cathead includes cabin, tails, platform and ladder
5. Telescoping cage does not include platform, ladder and hydraulic pump

Hook Heights / Freestanding

LC290 - 18t

Climbing / Tie - in Assembly

LC290 - 18t

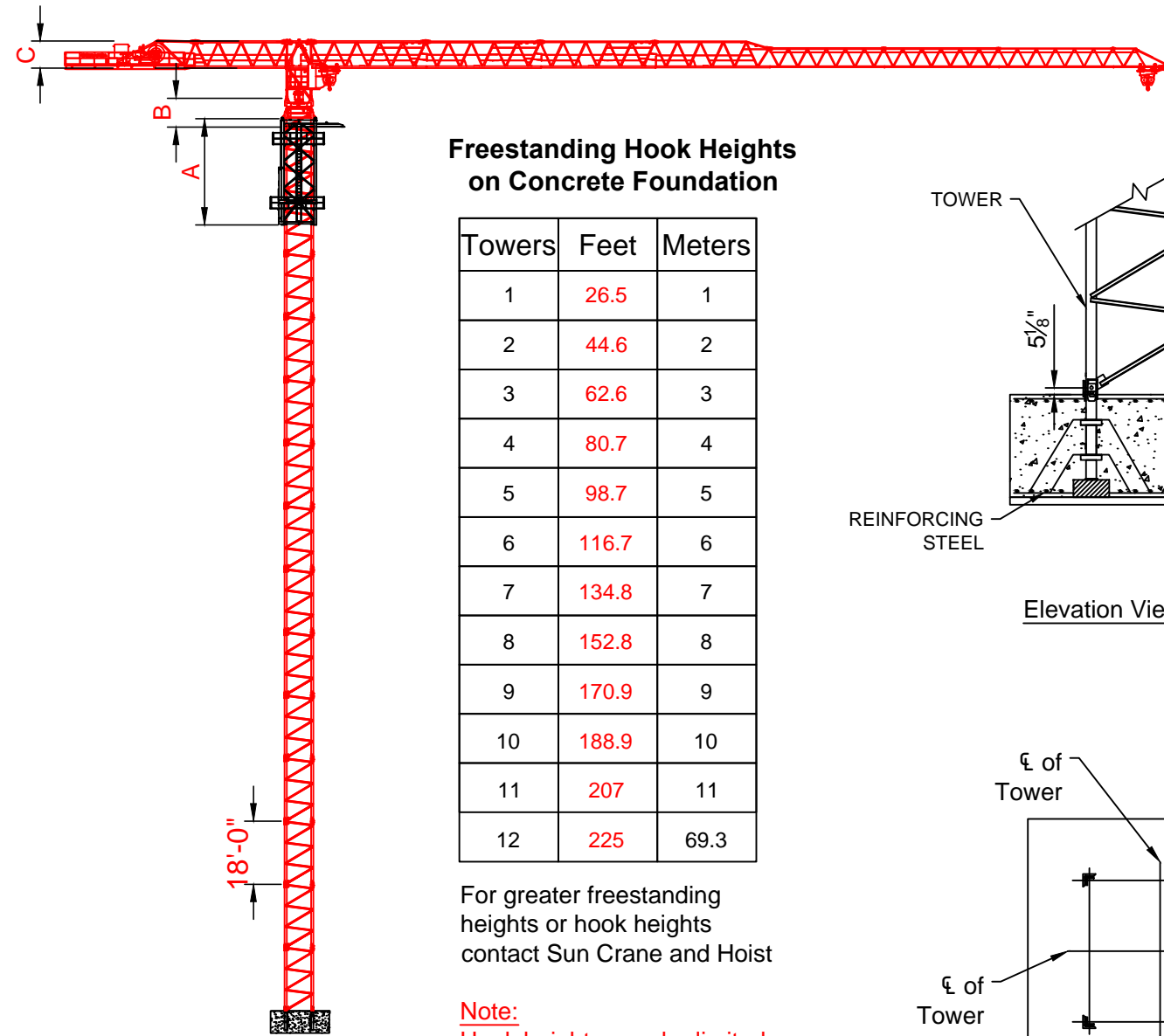

Freestanding Hook Heights on Concrete Foundation

Towers	Feet	Meters
1	26.5	1
2	44.6	2
3	62.6	3
4	80.7	4
5	98.7	5
6	116.7	6
7	134.8	7
8	152.8	8
9	170.9	9
10	188.9	10
11	207	11
12	225	69.3

For greater freestanding heights or hook heights contact Sun Crane and Hoist

Note:
Hook heights may be limited by geographic location

- A = Height of telescoping unit 30'-8" 9.3m
- B = Height of complete slewing unit 10'-4" 3.1m
- C = Height of jib section 8'-2" 2.5m

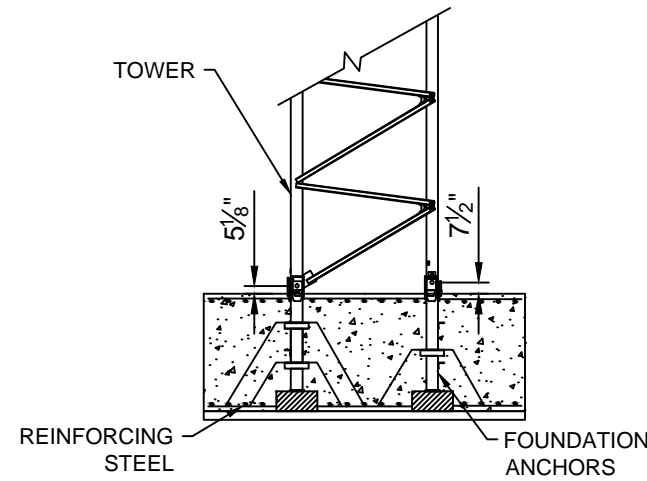

Elevation View of Anchors

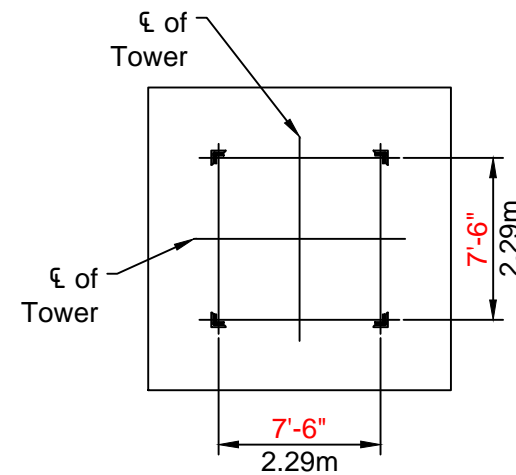

Plan View of Anchors

NOTE:

1. Lower or remove top unit prior to operating the crane.
2. If hook height exceeds 330 ft (100m) contact Sun Crane and Hoist for bracing instructions.

NOTE:

Tie-in installations may vary due to job site conditions. Contact SUN CRANE AND HOIST for information regarding dimensions and reaction forces.

The jib must be parallel to the face of building when climbing.

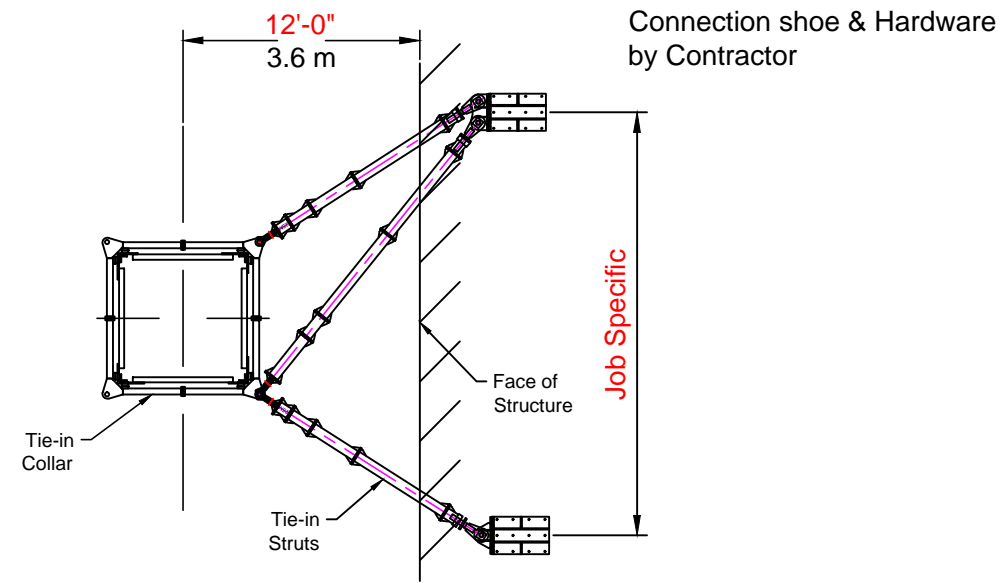

Tie-in Detail Plan View

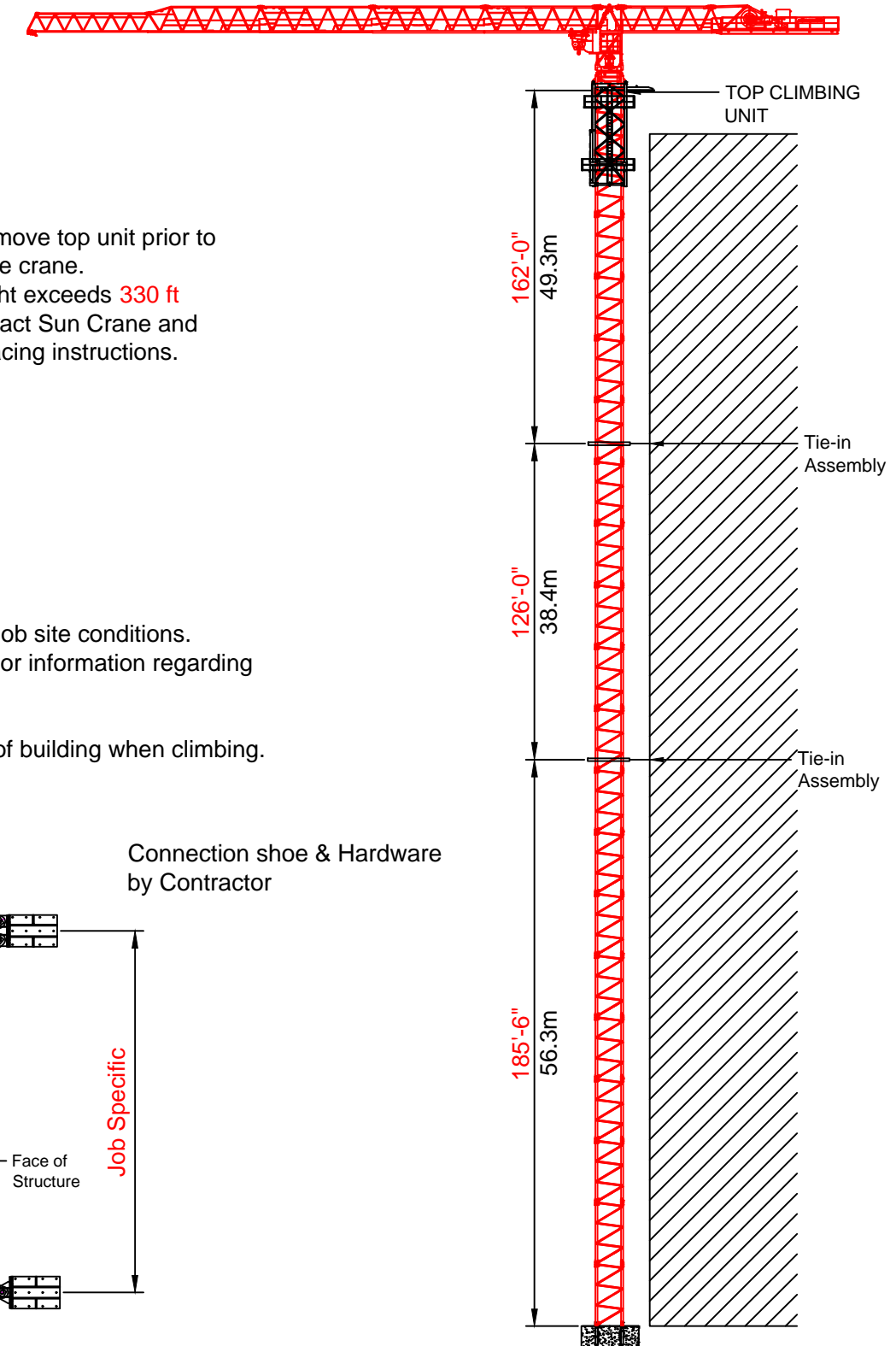

TOP CLIMBING